

CFA Heavy Tanker 3.4C

MODEL 1684 WATER TANK LEVEL INDICATING SYSTEM

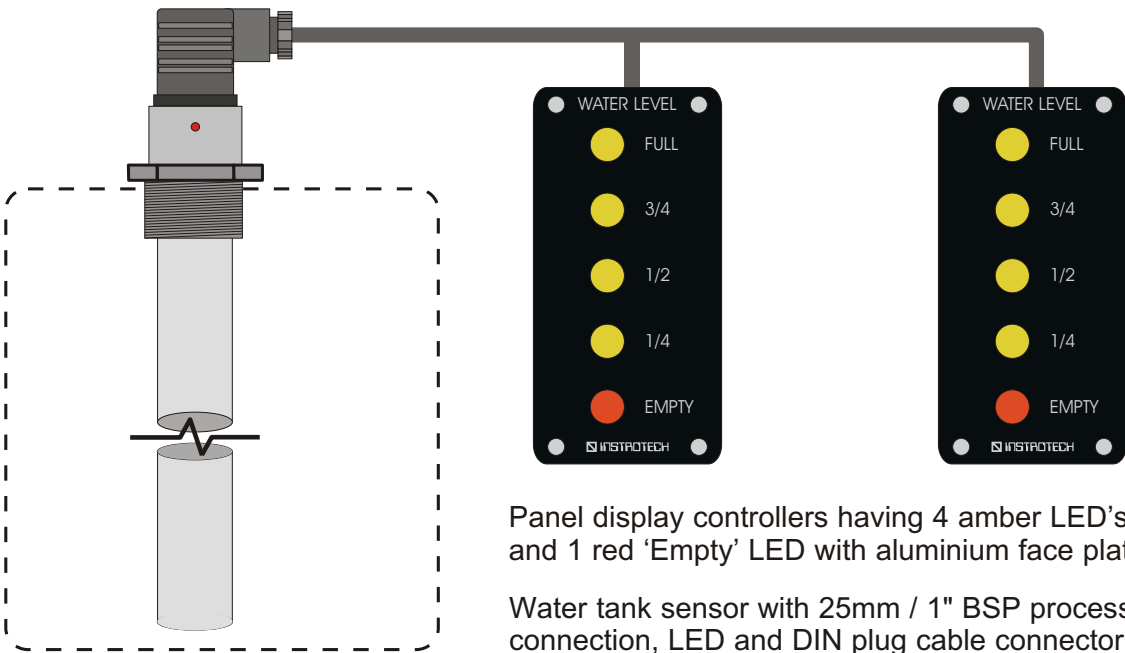

Panel display controllers having 4 amber LED's and 1 red 'Empty' LED with aluminium face plate

Water tank sensor with 25mm / 1" BSP process connection, LED and DIN plug cable connector

OPERATING FUNCTIONS :

LED DISPLAYS 1, 2, 3, 4 or 5 LED's are lit based on the water level in the tank.
 * All LED's flash if there are wiring or communication faults.
 * The top and bottom LED's flash if there is a Tank Sensor fault.

TANK SENSOR A blinking Tank Sensor LED shows normal communication with the LED Displays.
 * A permanently lit Tank Sensor LED shows power on only without communication.

*** IMPORTANT NOTICE - IF THE TOP AND BOTTOM LED's, OR ALL LED's AND THE STROBE ARE FLASHING, AND/OR THE SIREN SOUNDS CONTINUOUSLY, DO NOT RELY ON THE LEVEL SYSTEM FOR AN INDICATION OF THE WATER AVAILABLE SINCE THERE IS A FAULT !**

WIRING COLOURS :

For the wiring colours as above refer also to these labels fixed to the back of the LED display housings:

SUPPORT 1800 999 063

Instrotech Australia Pty Ltd
 P O Box 3137
 Newton SA 5074
 email: info@instrotech.com.au
www.instrotech.com.au
Tel (08) 8337 8033
 Fax +61 8 8337 8656

INSTROTECH
 Tel 1800 999 063

MODEL 1684-CFA34C
MASTER INDICATOR
 (Cab control console)

CABLE 1
 LW Amber/Amber - Green
 LW Siren - Brown
 CP Red Light - Blue
 CP Siren - Yellow
 CP Strobe - Purple
 Test Alarms - White
 Mute CP Siren - Black

CABLE 2
 +12 to 24VDC - Red
 Negative - Black
 Communication - Yellow

INSTROTECH
 Tel 1800 999 063

MODEL 1684-CFA34C
SLAVE INDICATOR
 (Pump/Engine panel)

CABLE 1
 +12 to 24VDC - Red
 Negative - Black
 Communication - Yellow

TANK SENSOR CONNECTOR



1 = +V
 2 = -V
 2 = Comm

CFA Heavy Tanker 3.4C WIRING DIAGRAMS

MODEL 1684-CFA34C WATER TANK LEVEL SYSTEM

CREW PROTECTION BACK-UP PROBE

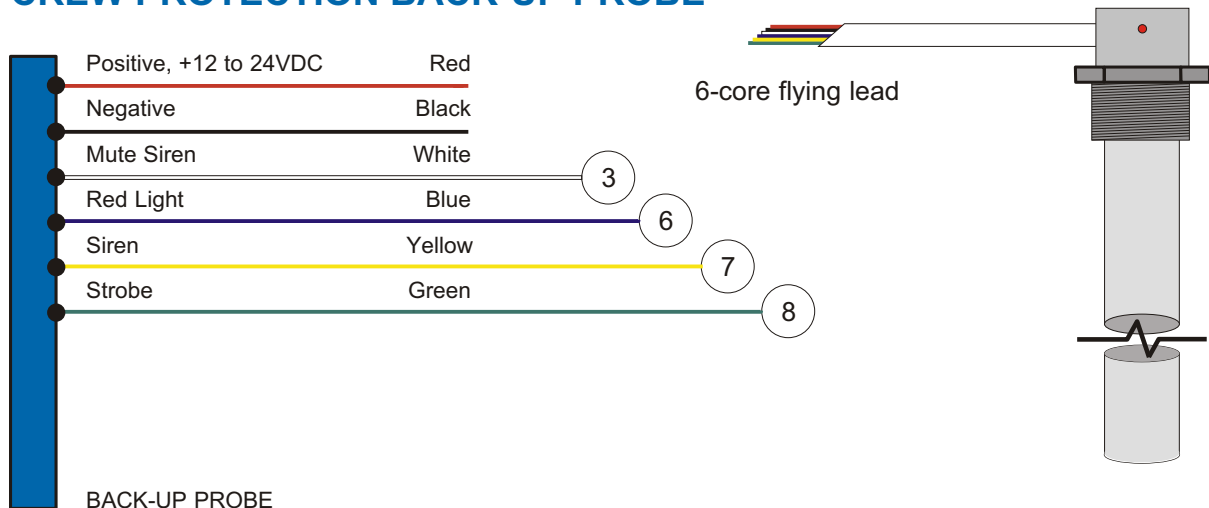

LOW LEVEL WATER INDICATION SYSTEM :

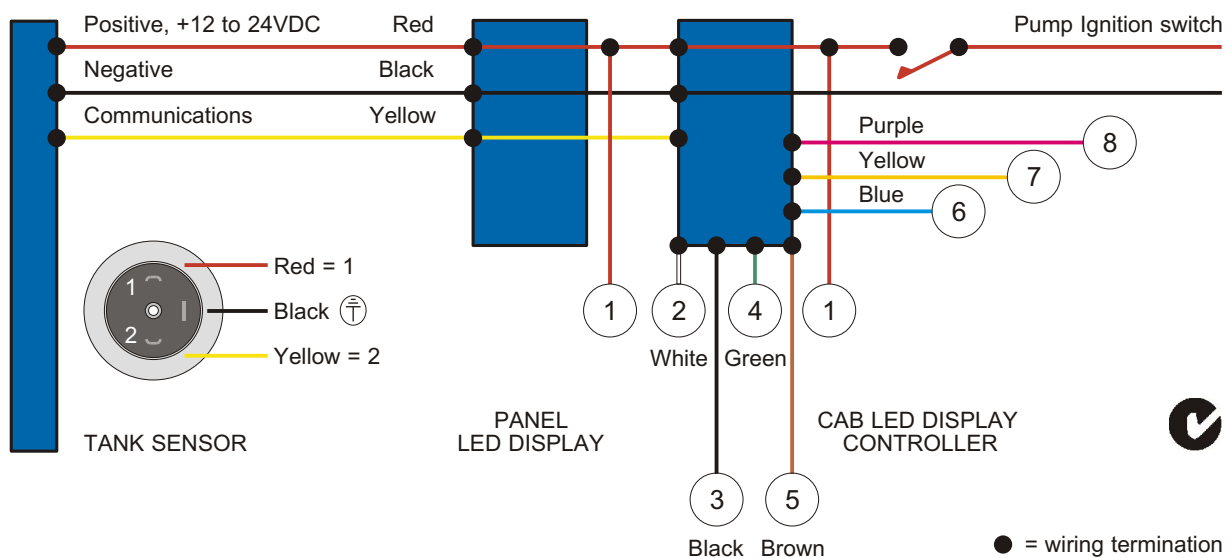

INPUTS:

- 1 Test current Water Level via momentary *positive supply switch* when Pump Ignition is Off
- 2 Test all Audible and Visual alarms via momentary *positive switch* when Pump is On or Off.
- 3 Mute audible 10-minute "Crew Protection" Siren via momentary switch to *negative*.

OUTPUTS: *Negative switching*

- 4 1/4 - Switch On "Low Water" Amber Strobe and Amber Light and Switch Off at 3/4.
- 5 1/4 - Switch On "Low Water" Siren for 5 seconds and Reset at the 3/4 level.
- 6 Empty - Switch On Visual "Crew Protection" Red Light and Switch Off at 1/4.
- 7 Empty - Switch On Audible "Crew Protection" Siren for 10 minutes and Switch Off at 1/4.
- 8 Empty - Switch On Visual "Crew Protection" Clear Strobe and Reset at the 3/4 level.