

### Truth Encore™ Dual Arm Operator

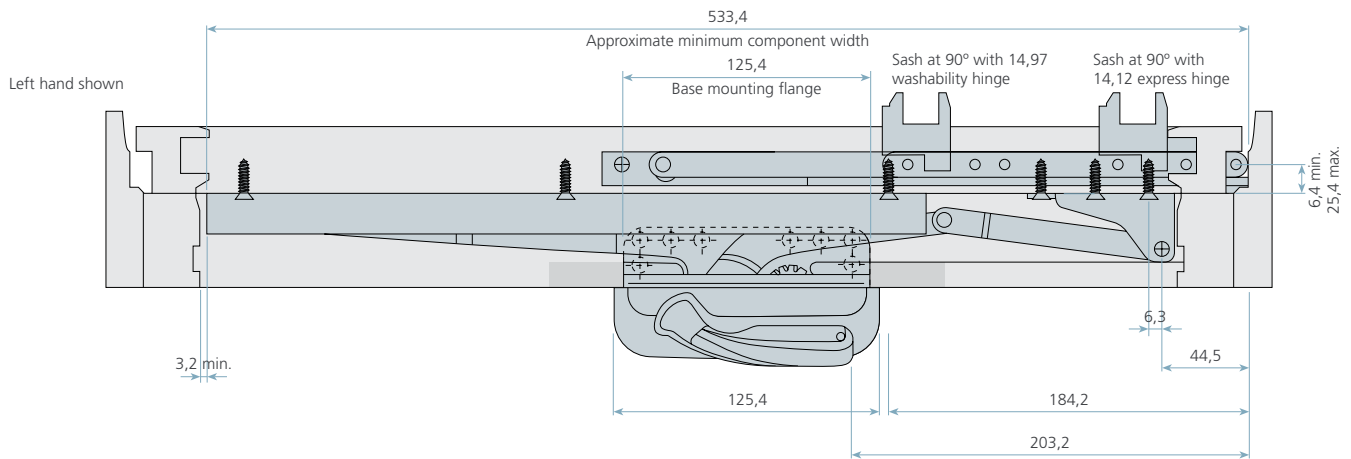

- Superior strength and performance combined with the flexibility of a snap fit cover and streamlined full-lip folding handle
- 33% less effort to operate than previous operators
- Operates sash sizes of 550 mm to 1000 mm wide and 2100 mm high
- Suitable for sash weights of up to 45 kg
- Provides up to 90° opening
- Provides over 177 mm of washability with the standard casement hinge
- Fully operable with fly screens
- Stainless steel available for coastal locations
- This product is covered by Truth's lifetime mechanical warranty.



#### Truth Encore™ Dual Arm Operator Components Part List



Casement - Left Hand



Casement - Right Hand

Part Number	Description	Part Number
T-50.10.00.211	Truth Encore™ Dual Arm Operator	T-50.10.00.212
T-11576.93	Encore Casement Track & Slider	T-11576.93
T-14691.93	Encore Stud Bracket	T-14690.93
T-12614.●●	Encore Handle & Cover See Page 1.6 for Truth Hardware Colour Chart	T-12616.●●

Contact your JP Hardware Representative for ordering information on the Encore Dual Arm Stainless Steel options.



### Truth Encore™ Dyad Operator

- Superior strength and performance combined with the flexibility of a snap fit cover and streamlined full-lip folding handle
- 33% less effort to operate than previous operators
- Operates sash sizes of 350 mm to 700 mm wide and 1800 mm high
- Suitable for sash weights of up to 25 kg
- Provides up to 90° opening
- Provides over 177 mm of washability with the standard casement hinge
- Fully operable with fly screens
- Stainless steel available for coastal locations
- This product is covered by Truth's lifetime mechanical warranty.



Timber



Aluminium



uPVC

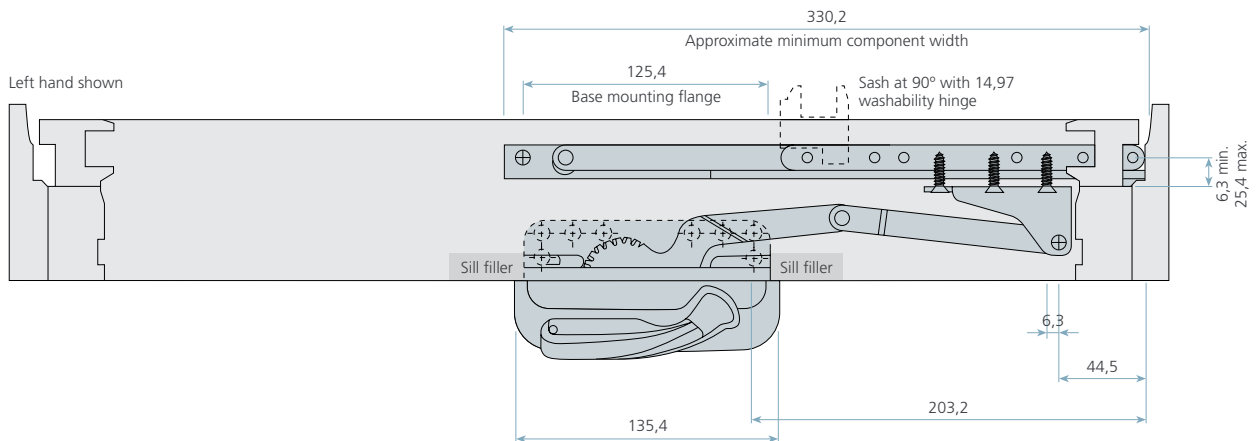

#### Truth Encore™ Dyad Operator Components Part List



Casement - Left Hand



Casement - Right Hand

Part Number	Description	Part Number
T-50.60.00.211	Truth Encore™ Dual Arm Operator	T-50.60.00.212
T-14691.93	Encore Stud Bracket	T-14690.93
T-12614.●●	Encore Handle & Cover See Page 1.6 for Truth Hardware Colour Chart	T-12616.●●

Contact your JP Hardware Representative for ordering information on the Encore Dyad Stainless Steel options.

### Truth Encore™ Single Arm Operator



- Uniquely designed for round top, half round, trapezoid, garden and octagon windows and windows that require butt hinges
- Operates sash sizes of 420 mm to 700 mm wide and 1800 mm high (sash size of 300 mm to 419 mm possible with a 'short' single arm operator\*)
- Suitable for sash weights of up to 30 kg
- Provides up to 90° opening
- Fully operable with fly screens
- Stainless steel available for coastal locations
- This product is covered by Truth's lifetime mechanical warranty



Timber



uPVC

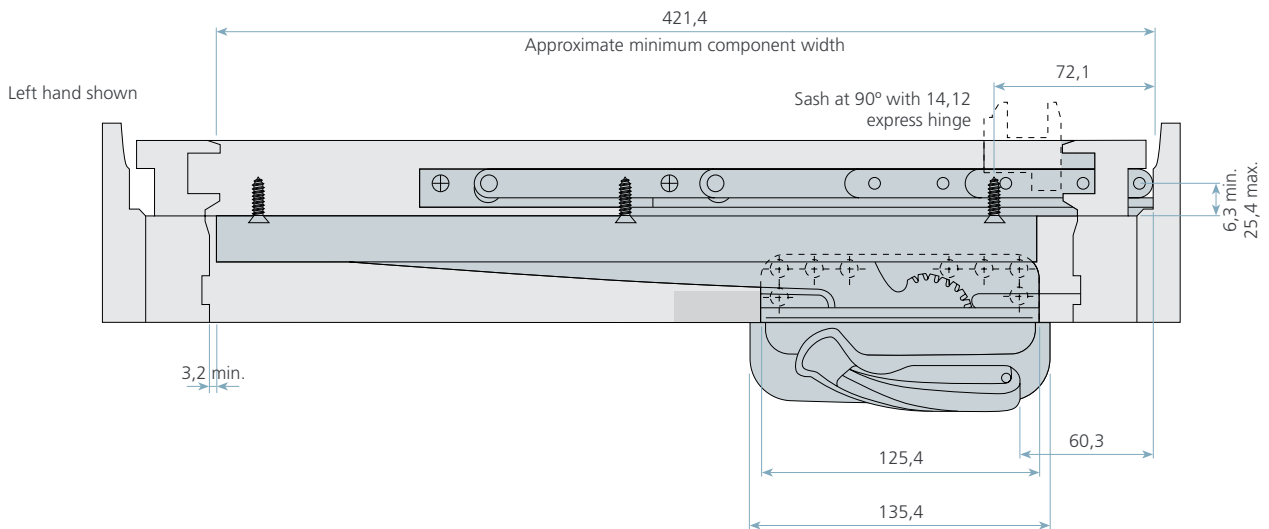

#### Truth Encore™ Dual Arm Operator Components Part List



Casement - Left Hand



Casement - Right Hand

Part Number	Description	Part Number
T-52.11.00.211	Truth Encore™ Dual Arm Operator	T-52.11.00.212
T-11576.93	Encore Casement Track & Slider	T-11576.93
T-12614.●●	Encore Handle & Cover See Page 1.6 for Truth Hardware Colour Chart	T-12616.●●

Contact your JP Hardware Representative for ordering information on the Encore Single Arm Stainless Steel options.



### Truth Encore™ Awning Operator

- Allows for a uniformed look throughout the home on casements and awnings
- Provides for maximum opening (approx. 370 mm) combined with wide 'pull-in' connection to sash
- 33% less effort to operate than previous operators and 50% less than conventional chain winders
- Operates sash sizes of 550 mm to 1500 mm wide and 2100 mm high
- Suitable for sash weights of up to 130 kg when used with appropriate stay
- Fully operable with fly screens
- Stainless steel available for coastal locations
- This product is covered by Truth's lifetime mechanical warranty



Timber



Aluminium



uPVC

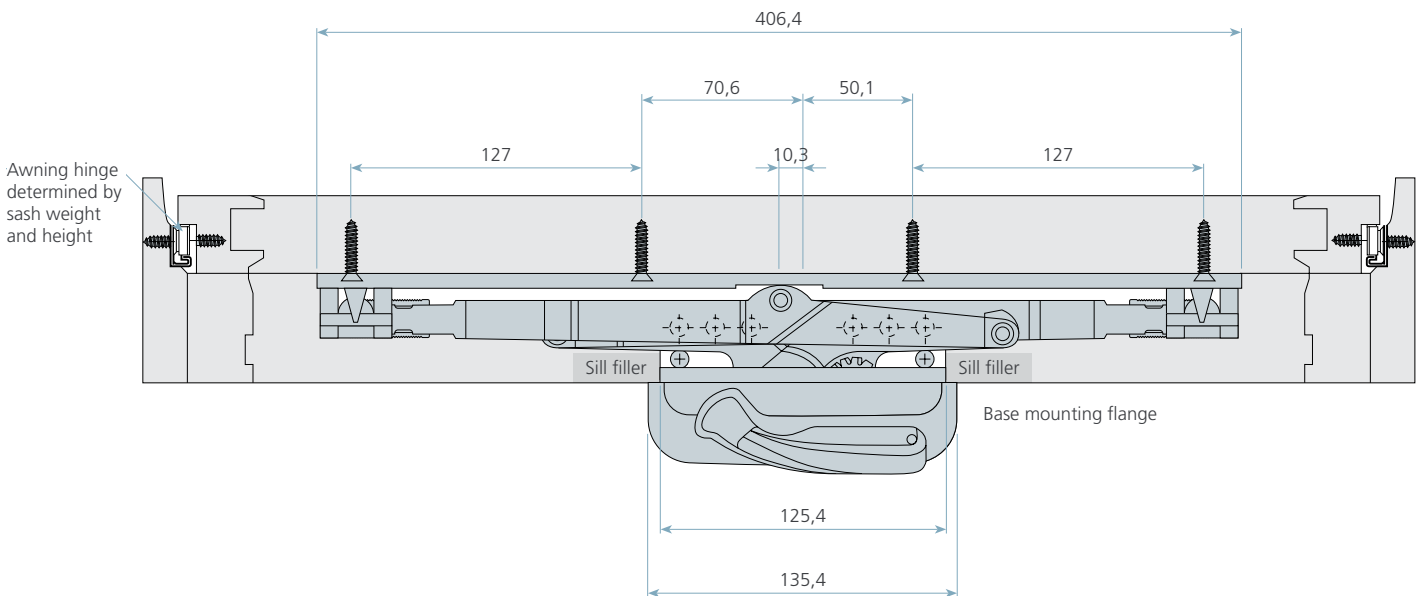

#### Truth Encore™ Dyad Operator Components Part List



Awning

Part Number	Description
T-51.10.00.211	Truth Encore™ Awning Operator - E-Grad
T-11577.93	Encore Track Assembly
T-12614.●●	Encore Handle & Cover See Page 1.6 for Truth Hardware Colour Chart

Contact your JP Hardware Representative for ordering information on the Encore Awning Stainless Steel options.

### Truth Skylight Operator



- Compatible with wood, metal or vinyl skylights, Manual Skylight Operators are easy to install, simple to use and can lift up to 140 lbs. with minimal effort. Strong plastic case liner keeps the chain and sprocket sliding smoothly, making windows easy to open
- Steel chain is detachable at the sash – ease of factory or field installations
- The sprocket and chain are made from hardened steel to provide years of continuous, chatter-free operation
- Electrostatically applied, durable coatings that provide excellent resistance to chipping, scratching and corrosion while maintaining colour stability for years in direct sunlight
- The worm gear is made from hardened steel for lasting service



Part No.	Description
T-42.65.●●	Truth Sklght Operator
T-10638	Pole
T-33604.●●	Universal with ring

Color Code	Description	Color Code	Description
01	Aluminium	32	White
02	Black	03	Bronze



Awning



Skylight



Skylight

### Interlock Manual Skylight Operator

- The Interlock manual skylight operator provides an attractive and user-friendly option for opening and closing hinged roof and high windows. With a host of features and options, the system allows ventilation and convenience, flexibility and safety.

Part No.	Description
IN-P4550●	Interlock skylight operator includes 2 sash brackets & pin ,pole receiver & crank handle
IN-P4554	Interlock Skyop Pole

Color Code	Description	Color Code	Description
BLK	Black	WHT	White



Timber



Aluminium



uPVC

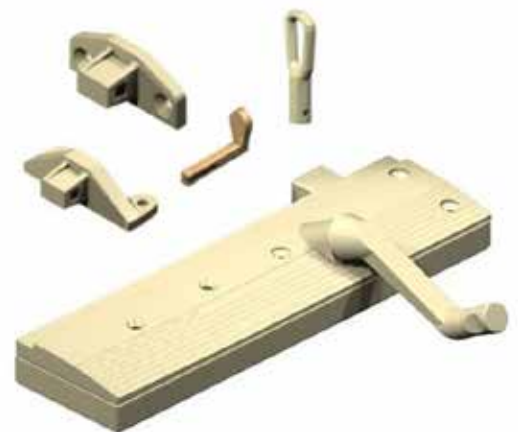

Awning



Skylight



Skylight



# COLOUR CHART



Aluminium  
(01)



Black  
(02)



Bronze  
(03)



Beige  
(24)



White  
(32)

### Decorative Finishes - Available on Request



Satin Nickel  
(19)



Bright brass  
(13)



Antique brass  
(14)



Bright chrome  
(35)



Oil rubbed bronze  
(52)

The samples shown above are representative of Truth's colours They are not actual samples. Consult a JP Hardware Representative for an actual sample, and for information(stock/non-stock) on traditional and decorative colours.

### Truth Homegard® Sash Lock

- Homegard Primary Sash Lock  
A low profile sash lock, designed to be used with Truth's entire range of operators. It's positive lock in provides up to 125kgs of negative air pressure and forced entry resistance per lock. It is also fully operable with flyscreens. This product is covered by Truth's lifetime mechanical warranty.

- Homegard Secondary Sash Lock  
Provides multi-point tandem locking when used in conjunction with Homegard Primary lock and a tie-bar. Ideal for Casement sashes over 1500mm in height

This product is covered by Truth's lifetime mechanical warranty.



### Truth Maxim® Multi-point & Single Point Locking System

The new Maxim® Sash Latch complements and completes the already popular Maxim® System. Available in both multi-point and single-point versions, the Maxim® Sash Latch provides the most attractive, easiest operating, highest performing, best value in casement and awning window latching hardware.

This product is covered by Truth's lifetime mechanical warranty.

For more information on sash control devices please contact your JP Hardware Representative.



### Truth Encore™ Multi-point Locking System

Providing trouble free operation with fully concealed locking and sequential engagement the Encore Multi-Point Locking System is the most complete locking system for casement and awning windows. The Encore Lock brings a number of new features unique to the window industry – including an option for securing round-top windows and a built-in construction handle which allows windows to be operable prior to painting or staining.

This product is covered by Truth's lifetime mechanical warranty.

For more information on sash control devices please contact your JP Hardware Representative.





### Truth 13 Series Awning Hinge

- These hinges balance a sash as it opens for smooth effortless operation. It is recommended to match the size of the hinge to the height and weight of the sash. Proper selection can help prevent problems such as window chatter.



Part No.	Height x Width(Max)	Weight (Max)	Minimum Height	Hinge Length
T-13.13	355.6 mm x 1500mm	3.2 Kg.	254 mm	245 mm
T-13.14	482.6 mm x 1500mm	9.1 Kg.	355.6 mm	355 mm
T-13.15	660.4 mm x 1500mm	17.3 Kg.	482.6 mm	475 mm
T-13.16	863.6 mm x 1500mm	22.7 Kg	660.4 mm	558 mm
T-13.17	1066.8 mm x 1500mm	27.7 Kg	863.6 mm	660 mm



Awning



### Truth 14 Series Casement Hinge

- These hinges balance a sash as it opens for smooth effortless operation. It is recommended to match the size of the hinge to the height and weight of the sash. Proper selection can help prevent problems such as window chatter.



Part No.	Height x Width(Max)	Weight (Max)	Minimum Width	Hinge Length
T-14.05	2100 mm x 813 mm	39 Kg.	305 mm	245 mm
T-14.97	2100 mm x 1016 mm	44 Kg.	305 mm	330.2 mm



Casement



### Truth 34 Series Casement Hinge

- Throughout the industry the names Anderberg and Truth have stood for reliable engineering and production, as well as precision made products and excellent support services; but above all this, these names stand for quality. This is most evident in our expertly crafted 4-Bar Hinges



Casement



### Truth Sash Control Device



**LIMIT DEVICES:** Two different varieties of Limit Devices are available. When properly installed and operated, the Limit Device will help prevent damage to casement and awning windows under high winds in high-rise applications. Two different methods of disconnecting the Limit Device from the sash for cleaning purposes - either by inserting a key, or by operating the detach clip. For more information on sash control devices please contact your JP Hardware Representative.



Awning



Casement

### Truth Snubbers



- Available in both concealed and visible styles - will prevent bowing of tall casement windows or wide awning windows. Have also been found to be useful with double hung windows in improving the seals of the bottom and top rails in the closed position. Adding a snubber may increase negative air pressure rating and resistance to forced entry.

This product is covered by Truth's lifetime mechanical warranty.



Awning



Casement



Balance Number	'C' Closed Dimension	'E' Extended Dimension	'L' Body Length	Number of pretension turns of spiral Kg		
				Weight Range 2.25-7.25kg	Weight Range 2 7.25-10 Kg	Weight Range 3 10-14 Kg
110	318	559	292	3		
200	343	610	318	3		
220	368	660	343	3		
240	394	711	368	3		
260	419	762	394	3		
280	445	813	419	3		
210	470	864	445	3		
300	495	914	470	3		
320	521	965	495	4		
340	546	1,016	521	4		
360	572	1,067	546	4		
380	597	1,118	572	4		
310	622	1,168	597	4		
400	648	1,219	622	4	5	6
420	673	1,270	648	4	5	6
440	699	1,321	673	4	5	6
460	724	1,372	699	5	5	6
480	749	1,422	724	5	5	6
410	775	1,473	749	5	5	6
500	800	1,524	775	5	5	6
520	826	1,575	800	5	5	6
540	851	1,626	826	6	6	6
560	876	1,676	851	6	6	7
580	902	1,727	876	6	6	7
510	927	1,778	902	6	6	7
600	953	1,829	927	6	6	7
620	978	1,880	953	6	6	7
640	1,003	1,930	978	7	7	7
660	1,029	1,981	1,003	7	7	8
680	1,054	2,031	1,029	7	7	8
610	1,080	2,083	1,054	7	7	8
700	1,105	2,134	1,080	7	7	8
720	1,130	2,183	1,105	7	7	8

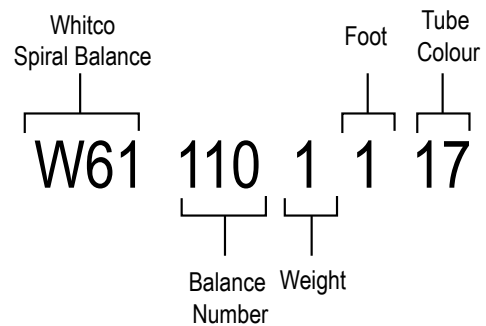
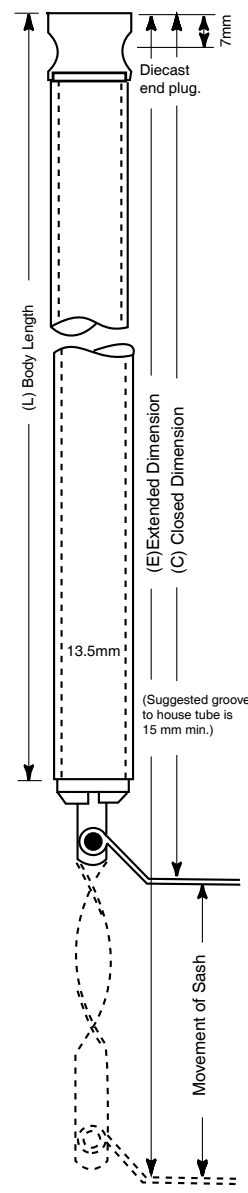

**Legend:**

- Balance Number - Refer to size chart (above)
- Weight Range:
  - 1 = 2.25 to 7.25kg
  - 2 = 7.25 to 10.0kg
  - 3 = 10.0 to 14.0kg
- Foot:
  - 0 = No Foot
  - 1 = Standard Foot Included
- Colour:
  - 17 = Black

To select a whitco sash balance tube unit size

**Top Sash**

1. Measure the top sash height.
2. Refer to appropriate closed "C" dimension on table.
3. If top sash height does not exactly, go down to next size. Note - the closed dimension "C" must be less than the sash height.

**Bottom Sash**

1. Establish overall opening height.
2. Refer to extended "E" dimension on drawing.
3. If opening height does not exactly, go up to next size.
4. Read off Balance Number.

Remember: When closed the bottom sash has the tube in the extended position, and the top sash is in the closed position. Important: Always ensure that you select the correct type of balance to match the weight and size of sash. Included



Double Hung



Timber



Aluminium

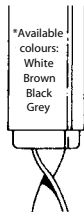
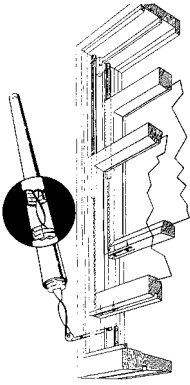

Available colours: White, Brown, Black, Grey  
 TYPE 'D' STANDARD 14mm DIAMETER TO SUIT 16mm x 16mm REBATE SASH WEIGHT UP TO 13.5kg

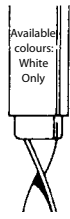

Available colours: White Only  
 TYPE 'A' 9.5mm DIAMETER TO SUIT 11mm x 11mm REBATE SASH WEIGHT UP TO 8kg

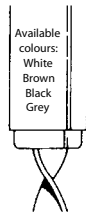

Available colours: White, Brown, Black, Grey  
 TYPE 'B' 12.4mm DIAMETER TO SUIT 14mm x 14mm REBATE SASH WEIGHT UP TO 13.5kg

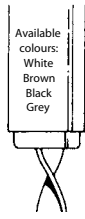

Available colours: White, Brown, Black, Grey  
 TYPE 'HD' 12.4mm DIAMETER TO SUIT 14mm x 14mm REBATE SASH WEIGHT UP TO 17.5kg



### UNIQUE SASH BALANCES



Double Hung



Timber



Aluminium

\* Note: Type 'D' in visual pack is available in grey only

For window sizes over mm	For window sizes up to mm	Tube length mm	Sash Balance No.	Type 'D' Sash Balance Part No. EACH	Type 'A' Sash Balance Part No. EACH	Type 'B' Sash Balance Part No. EACH	Type 'HD' Sash Balance Part No. EACH
635mm	690mm	330mm	10	A01D/10	A01A/10	A01B/10	
690mm	735mm	355mm	11	A01D/11	A01A/11	A01B/11	
735mm	785mm	380mm	12	A01D/12	A01A/12	A01B/12	
785mm	840mm	405mm	13	A01D/13	A01A/13	A01B/13	
840mm	890mm	430mm	14	A01D/14	A01A/14	A01B/14	
890mm	940mm	455mm	15	A01D/15	A01A/15	A01B/15	
940mm	990mm	485mm	16	A01D/16	A01A/16	A01B/16	
990mm	1040mm	510mm	17	A01D/17	A01A/17	A01B/17	
1040mm	1090mm	535mm	18	A01D/18	A01A/18	A01B/18	
1090mm	1145mm	560mm	19	A01D/19	A01A/19	A01B/19	
1145mm	1195mm	585mm	20	A01D/20	A01A/20	A01B/20	A01HD/20
1195mm	1245mm	610mm	21	A01D/21	A01A/21	A01B/21	A01HD/21
1245mm	1295mm	635mm	22	A01D/22	A01A/22	A01B/22	A01HD/22
1295mm	1345mm	660mm	23	A01D/23	A01A/23	A01B/23	A01HD/23
1343mm	1395mm	690mm	24	A01D/24	A01A/24	A01B/24	A01HD/24
1395mm	1450mm	715mm	25	A01D/25	A01A/25	A01B/25	A01HD/25
1450mm	1500mm	735mm	26	A01D/26	A01A/26	A01B/26	A01HD/26
1500mm	1550mm	760mm	27	A01D/27	A01A/27	A01B/27	A01HD/27
1550mm	1600mm	785mm	28	A01D/28	A01A/28	A01B/28	A01HD/28
1600mm	1650mm	815mm	29	A01D/29	A01A/29	A01B/29	A01HD/29
1650mm	1700mm	840mm	30	A01D/30	A01A/30	A01B/30	A01HD/30
1700mm	1755mm	865mm	31	A01D/31	A01A/31	A01B/31	A01HD/31
1755mm	1805mm	890mm	32	A01D/32	A01A/32	A01B/32	A01HD/32
1805mm	1855mm	915mm	33	A01D/33			A01HD/33
1855mm	1905mm	940mm	34	A01D/34			A01HD/34
1905mm	1955mm	965mm	35	A01D/35			A01HD/35
1955mm	2005mm	990mm	36	A01D/36			A01HD/36
2005mm	2055mm	1015mm	37	A01D/37			A01HD/37
2055mm	2110mm	1040mm	38	A01D/38			A01HD/38
2110mm	2160mm	1065mm	39	A01D/39			A01HD/39
2160mm	2210mm	1090mm	40	A01D/40			A01HD/40
2210mm	2260mm	1115mm	41	A01D/41			A01HD/41
2260mm	2310mm	1145mm	42	A01D/42			A01HD/42
2310mm	2360mm	1170mm	43	A01D/43			A01HD/43
2360mm	2415mm	1195mm	44	A01D/44			A01HD/44
2415mm	2465mm	1220mm	45	A01D/45			A01HD/45
2465mm	2515mm	1245mm	46	A01D/46			A01HD/46
2515mm	2590mm	1270mm	47	A01D/47			A01HD/47
2590mm	2615mm	1295mm	48	A01D/48			A01HD/48



# WINDOW SYSTEMS

## BALANCE SYSTEM

### Whitco Spiral Tension Key



Part No.	Description	Box Qty.
W492700	Whitco Spiral Tension Key	200

### Adjustable Spiral Foot



Part No.	Description	Box Qty.
W615100	Whitco Adjustable Spiral Std. Foot	200
W615300	Whitco Adjustable Spiral Foot Super Heavy Duty	200
GA - APT01/UC1	Unique UCI Foot	200

### Whitco Spiral Foot



Part No.	Description	Box Qty.
W615200	Whitco Spiral Balance Foot TFD	200

### Spiral Accessory Kit



Part No.	Description	Box Qty.
W492916	Whitco Accessory Kit White	200
W492900	Whitco Accessory Kit Black	200
GA - APT01/ACC	Unique Accessory Kit Black	200

### Whitco Long Stop



Part No.	Description	Box Qty.
W493000	Whitco Long Stop	200

# WINDOW SYSTEMS

## COUNTER BALANCED SYSTEM



### Counter Balanced Double Hung Window System

• Pulley system allows perfect counter balancing of window frames.  
 Suitable for all sash sizes, very easy operation with large sashes.

- The closest thing to box frames without the expense of weights and cords
- Perfect for Renovations / Restorations
- 10 Year Warranty on pulley
- Maximum sash weight up to 60 kg.
- Slim line and unobtrusive design



Dual Roller Pulley



Sash Cord Fastener

Part No.	Description	Box Qty.
JPR-45252SSG	Dual Roller Pulley for Counter Balance	1
AI-Z-SS25DSGA	Dual Roller Pulley for Counter Balance	1
JPA-EV1	Sash Cord Fastener	1



Double Hung



Timber

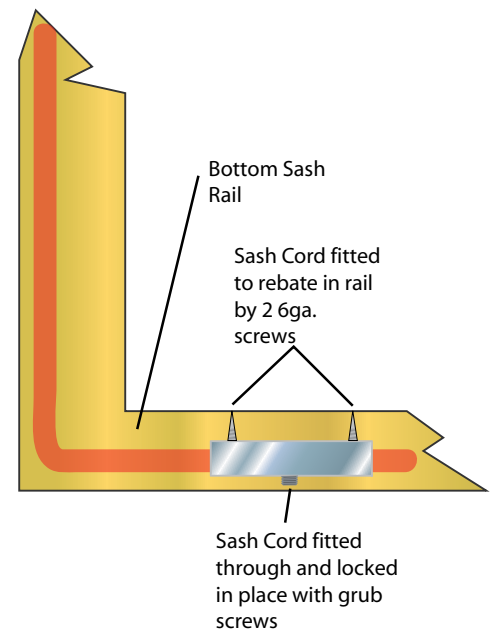
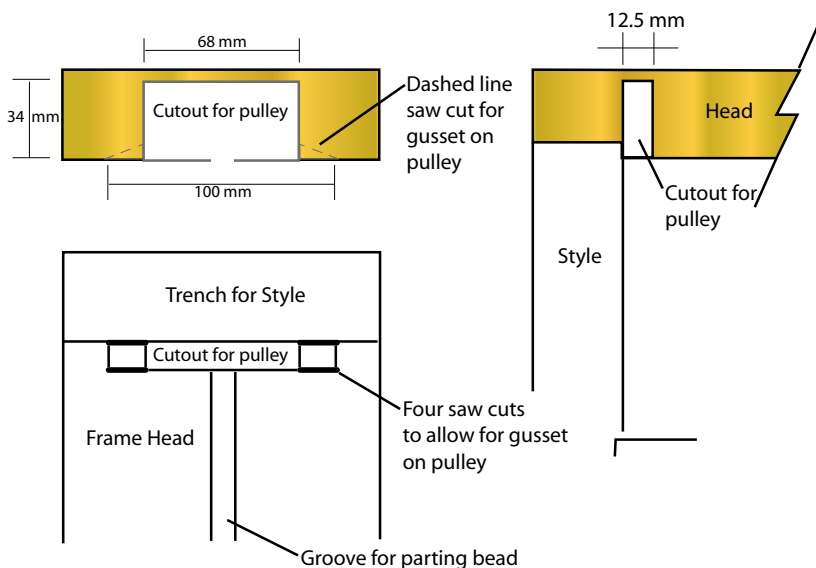
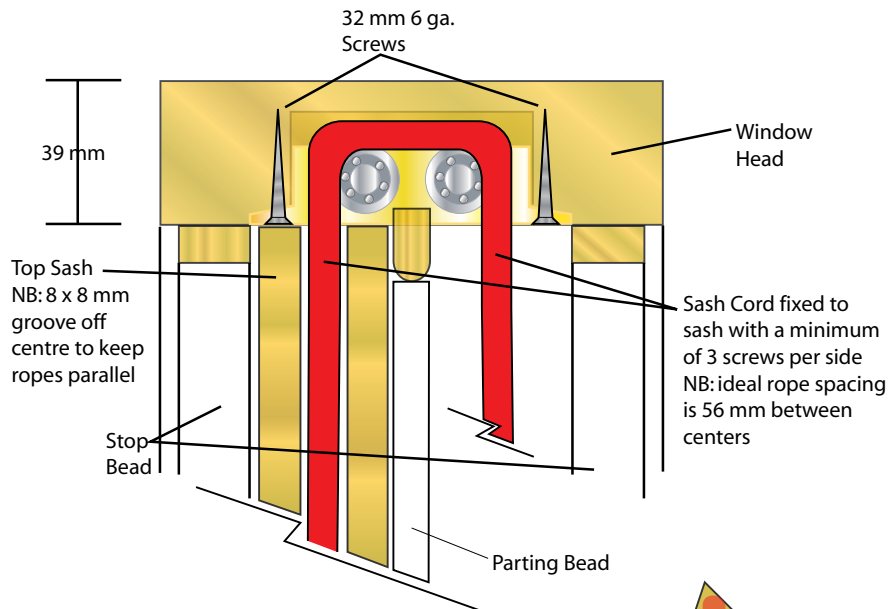

### Brass Double Hung Pulleys



Part No.	Description	Box Qty.
SU-3114	Superior Brass 125mm x 25mm - Brass	5
SU-43114	Superior Brass 125mm x 25mm - Satin Chrome	5
SU-33114	Superior Brass 125mm x 25mm - Bright Chrome	5



Double Hung



Timber

### Plastic Double Hung Pulleys



Part No.	Description	Box Qty.
AI-JP1090	Plastic Carriage Nylon Wheel 22Kg.	25
AI-JP1092	Plastic Carriage Brass Wheel 36Kg.	25



Double Hung



Timber

### Brass Double Hung Pulleys



Part No.	Description	Box Qty.
KI-9-300-16	Brass Double Hung	25



Double Hung



Timber

### Counter Balance Pulley Single Wheel



Part No.	Description	Box Qty.
	Steel Carriage Nylon Wheel 20Kg.	25



Double Hung



Timber

# WINDOW SYSTEMS

## COUNTER BALANCED SYSTEM



### 38mm(Diam) Lead Weight

Part No.	Description
CA-I1535	Lead Weight 38mm x 2000mm (26 kg)
JPH-EYES	Eyes Only - 46mm x 4.8mm (12mm 1D) -Zinc
	Other Sizes
CA-WW38385	Lead Weight 38mm x 385mm (5 kg)
CA-WW38615	Lead Weight 38mm x 615mm (8 kg)
CA-WW38770	Lead Weight 38mm x 770mm (10 kg)
CA-WW40510	Lead Weight 40mm x 510mm (7 kg)
CA-WW422500	Lead Weight 42mm x 2500mm (35 kg)
CA-WW501105	Lead Weight 50mm x 1150mm (25.9 kg)
CA-WW501200	Lead Weight 50mm x 1200mm (27 kg)
CA-WW501400	Lead Weight 50mm x 1400mm (31.5 kg)
CA-WW501550	Lead Weight 50mm x 1550mm (38.9 kg)

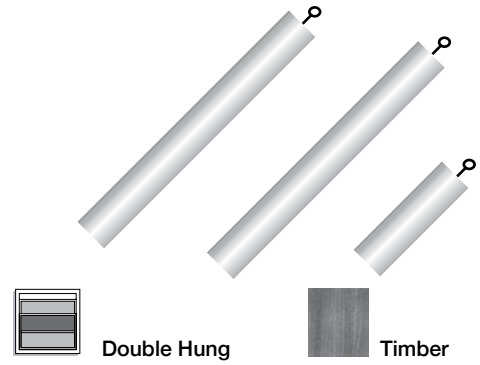

### Pre-Streached Nylon Cord

Part No.	Description	Box Qty.
JPH-8P-5W	5 mm 100mtr Roll White	1
JPH-8P-6W	6 mm 100mtr Roll White	1



### Cotton Sash Cord

Part No.	Description	Box Qty.
JPH-SCORD6	6mm - 250m Roll	1
JPH-SCORD8	8mm - 100m Roll	1





Slim line design in both 102mm and 152mm blades. Manufactured from low maintenance aluminum in both powder coat and anodised finishes. Using high impact U.V. resistant polypropylene clips Suitable for both residential and commercial applications with insect and security screens an integral part of the perimeter frame. Options included an attractive security bar system, and both remote and dual options.



Number Blades	102mm (4") Blades					152mm (6") Blades				
	Control	Blade Split	Height (mm)	Frame Height	Part Number	Control	Blade Split	Height (mm)	Frame Height	Part Number
2	N/A	N/A		N/A	N/A	Single	2	305	355	DL-20-X02
3	Single	3	292	342	DL-21-X03	Single	3	445	495	DL-20-X03
4	Single	4	381	431	DL-21-X04	Single	4	585	635	DL-20-X04
5	Single	5	470	520	DL-21-X05	Single	5	725	775	DL-20-X05
6	Single	6	559	609	DL-21-X06	Dual	3,3	865	915	DL-20-X06
7	Single	7	648	698	DL-21-X07	Dual	3,4	1005	1055	DL-20-X07
8	Dual	4,4	737	787	DL-21-X08	Dual	4,4	1145	1195	DL-20-X08
9	Dual	4,5	826	876	DL-21-X09	Dual	5,4	1285	1335	DL-20-X09
10	Dual	5,5	915	965	DL-21-X10	Dual	5,5	1425	1475	DL-20-X10
11	Dual	5,6	1004	1054	DL-21-X11	Triple	3,4,4	1565	1615	DL-20-X11
12	Dual	6,6	1093	1143	DL-21-X12	Triple	4,4,4	1705	1755	DL-20-X12
13	Dual	6,7	1182	1232	DL-21-X13	Triple	5,4,4	1845	1895	DL-20-X13
14	Dual	7,7	1271	1321	DL-21-X14	Triple	5,5,4	1985	2035	DL-20-X14
15	Triple	5,5,5	1360	1410	DL-21-X15	Triple	5,5,5	2125	2175	DL-20-X15
16	Triple	5,5,6	1449	1499	DL-21-X16	Quad	4,4,4,4	2265	2315	DL-20-X16
17	Triple	5,6,6	1538	1588	DL-21-X17	Quad	5,4,4,4	2405	2455	DL-20-X17
18	Triple	6,6,6	1627	1677	DL-21-X18	N/A	N/A	N/A	N/A	N/A
19	Triple	6,6,7	1716	1766	DL-21-X19	N/A	N/A	N/A	N/A	N/A
20	Triple	6,7,7	1805	1855	DL-21-X20	N/A	N/A	N/A	N/A	N/A
21	Triple	7,7,7	1894	1944	DL-21-X21	N/A	N/A	N/A	N/A	N/A
22	Quad	5,5,6,6	1983	2033	DL-21-X22	N/A	N/A	N/A	N/A	N/A
23	Quad	5,5,6,7	2072	2122	DL-21-X23	N/A	N/A	N/A	N/A	N/A
24	Quad	5,6,6,7	2161	2211	DL-21-X24	N/A	N/A	N/A	N/A	N/A
25	Quad	6,6,6,7	2250	2300	DL-21-X25	N/A	N/A	N/A	N/A	N/A
26	Quad	6,6,7,7	2339	2389	DL-21-X26	N/A	N/A	N/A	N/A	N/A
27	Quad	6,7,7,7	2428	2478	DL-21-X27	N/A	N/A	N/A	N/A	N/A



### Fixed Glass Extension Piece

DIAMOND LOUVRES  
Australia

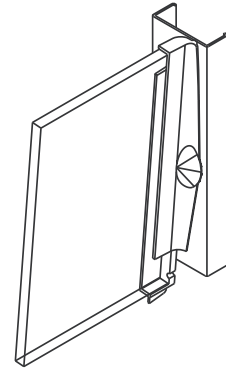

Part No.	Description
DL-20-	Fixed Glass Extension Piece

### Stacking Sleeve

DIAMOND LOUVRES  
Australia

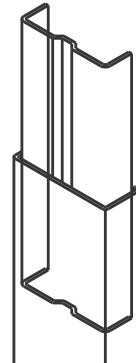

Part No.	Description
DL-20-161	Stacking Sleeve

### Remote Control Adaptor

DIAMOND LOUVRES  
Australia

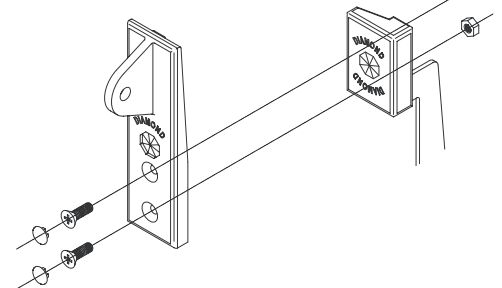

Part No.	Description
DL-20-168	Remote Control Adaptor

### Torsion Bar Adaptor

DIAMOND LOUVRES  
Australia

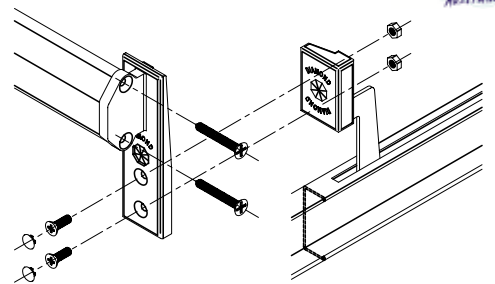







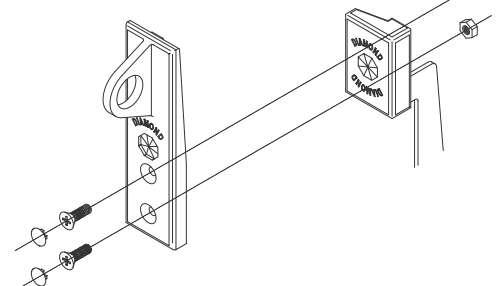



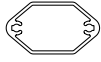
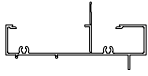



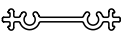

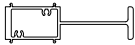
Part No.	Description
DL-20-170	Torsion Bar Adaptor

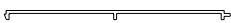
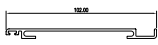
### Map Hook Adaptor

DIAMOND LOUVRES  
Australia



Part No.	Description
DL-20-159	Map Hook Adaptor

	Part No.	Description
	DL-600-506	Torsion Bar
	DL-600-700	Frame Jamb
	DL-600-701	Frame Sill
	DL-600-702	Weather Bar Adaptor
	DL-600-703	Weather Bar 40mm
	DL-600-704	Cyclon W/Bar 40mm
	DL-600-705	Gallery Coupler
	DL-600-706	Box Coupler 42x25mm
	DL-600-707	H/Duty Coupler 97mm
	DL-600-708	150mm Metal Blade
	DL-600-709	150mm Metal Blade Back
	DL-600-710	102mm Metal Blade
	DL-600-711	102mm Metal Blade Back
	DL-600-719	Extruded Insect Screen
	DL-600-720	Frame Head
	DL-600-721	High Lite Adaptor
	DL-600-722	100mm Frame Coupler
	DL-700-414	Flush Infil
	DL-LSS-309	High Lite Sill
	DL-LSS-402	Glazing Bead