

Schelgel Polypile Fringe Pile



• For sealing gaps at the edges of swing doors, roller shutters and other similar, narrow profile applications.

For added, long-lasting performance, all Schlegel pile weatherstripping is:

- U.V. Stabilized
- Silicone-treated to repel water
- Resistant to mold, mildew, and corrosion
- Acid and alkaline resistant
- Easy to install

All Stock available by the metre.



Part No.	Pile Length	Length
SC-PS11 •	11mm	600 mm
SC-PS13 •	13mm	500 mm
SC-PS16 •	16mm	500 mm
SC-PS20 •	20mm	300 mm
SC-PS28 •	28mm	100 mm

Color Code	Description
G	Grey

Color Code	Description
B	Black

Aluminium

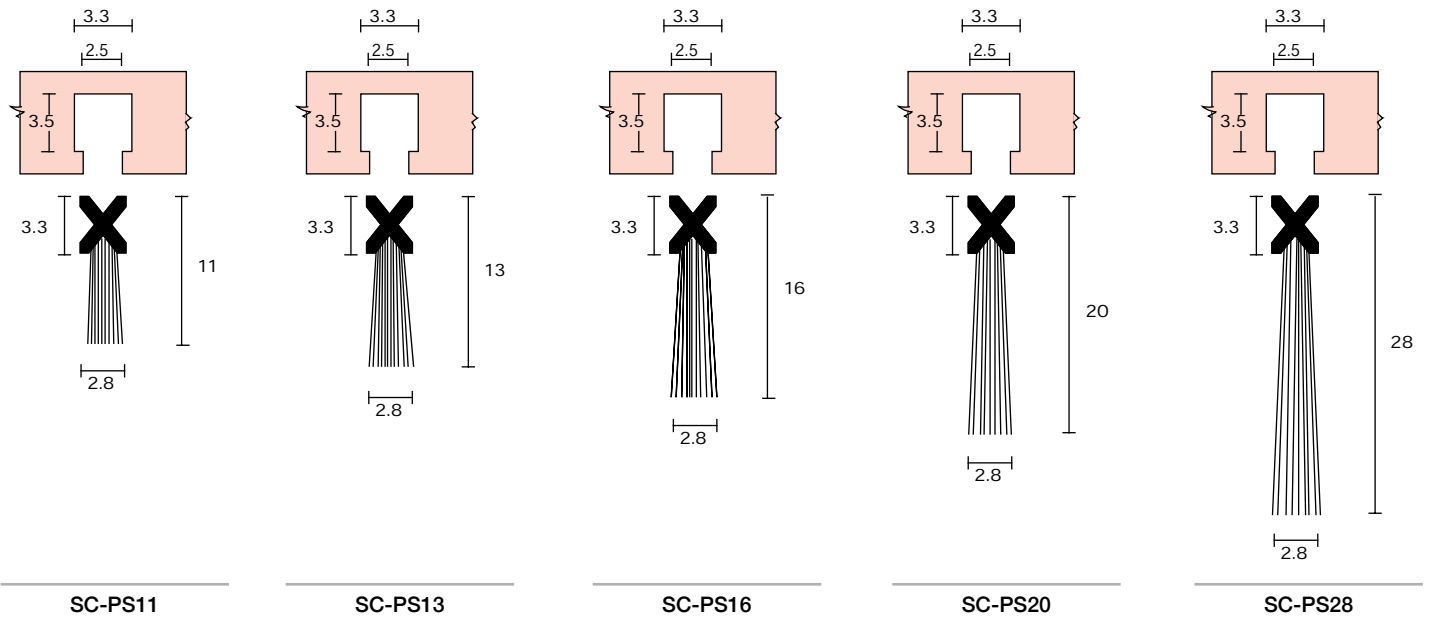

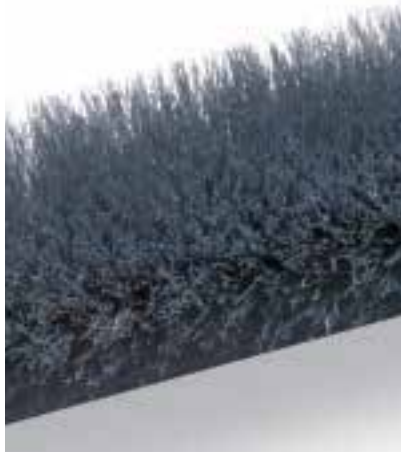

Schlegel Poly-bond Weatherstripping

• Consists of woven polypropylene pile and a tough polypropylene backing that's ideal for keeping out drafts, water, noise, and more. And, in addition to offering great sealing protection, POLY-BOND's pile fibers:

- Move independently to seal against irregular surfaces
- Resist abrasion
- Prevent sticking or binding, due to low friction design

For added, long-lasting performance, all SCHLEGEL pile weatherstripping is:

- U.V. Stabilized
- Silicone-treated to repel water
- Resistant to mold, mildew, and corrosion
- Acid and alkaline resistant
- Easy to install

All Stock available by the metre.

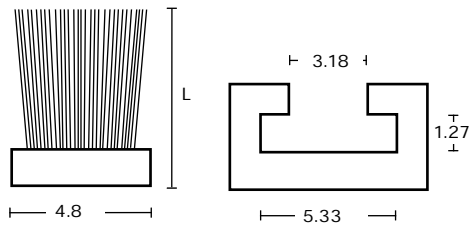

SC-PB48

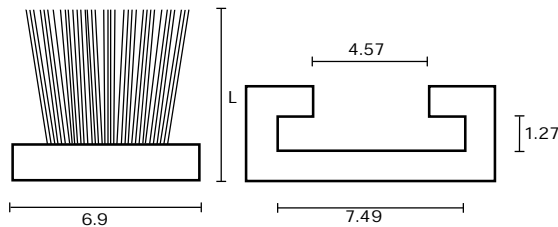

SC-PB69

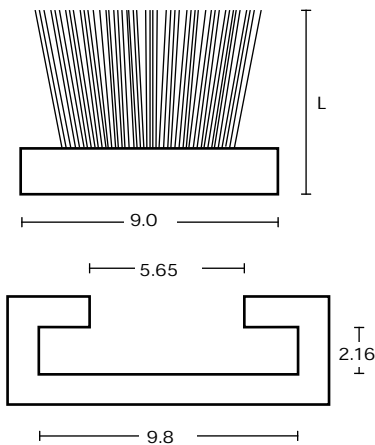

SC-PB90

Part No.	Pile Length (L)	Length
SC-PB48.350 •	3.50mm	600m
SC-PB48.375 •	3.75mm	600m
SC-PB48.400 •	4.00mm	600m
SC-PB48.425 •	4.25mm	550m
SC-PB48.450 •	4.50mm	550m
SC-PB48.500 •	5.00mm	500m
SC-PB48.525 •	5.25mm	500m
SC-PB48.550 •	5.50mm	450m
SC-PB48.600 •	6.00mm	450m
SC-PB48.650 •	6.50mm	400m
SC-PB48.750 •	7.50mm	350m

SC-PB69.350 •	3.50mm	600m
SC-PB69.425 •	4.25mm	500m
SC-PB69.450 •	4.50mm	450m
SC-PB69.500 •	5.00mm	450m
SC-PB69.525 •	5.25mm	450m
SC-PB69.575 •	5.75mm	400m
SC-PB69.600 •	6.00mm	400m
SC-PB69.625 •	6.25mm	350m
SC-PB69.650 •	6.50mm	350m
SC-PB69.750 •	7.50mm	300m
SC-PB69.800 •	8.00mm	300m
SC-PB69.1275 •	12.75mm	200m

SC-PB90.6.25 •	6.25mm	200m
SC-PB90.700 •	7.00mm	200m
SC-PB90.900 •	9.00mm	150m

Color Code	Description	Color Code	Description
G	Grey	B	Black



Schlegel Fin-Seal Weatherstripping



• Provides even more sealing protection from drafts, water, dust, and noise through a combination of its tough polypropylene construction and a durable central sealing fin. And now, FIN-SEAL's EZ Fin option allows for simple installation in PVC, with its low coefficient of friction. Plus:

- Central fin acts as an additional, effective barrier against air infiltration and water penetration
- Both pile and central fin are U.V. stabilized
- Low friction design prevents sticking or binding

For added, long-lasting performance, all Schlegel pile weatherstripping is:

- U.V. Stabilized
- Silicone-treated to repel water
- Resistant to mold, mildew, and corrosion
- Acid and alkaline resistant
- Easy to install

Part No.	Pile Length (L)	Length
SC-PBF48.425	4.25mm	500m
SC-PBF48.475	4.75mm	500m
SC-PBF48.550	5.50mm	450m
SC-PBF48.600	6.00mm	400m
SC-PBF48.650	6.50mm	400m
SC-PBF48.800	8.00mm	300m
SC-PBF69.500	5.00mm	300m
SC-PBF69.550	5.50mm	400m
SC-PBF69.650	6.50mm	350m
SC-PBF69.900	9.00mm	200m

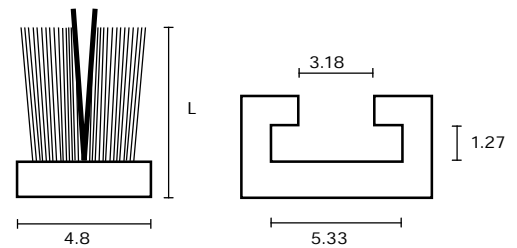

SC-PBF48

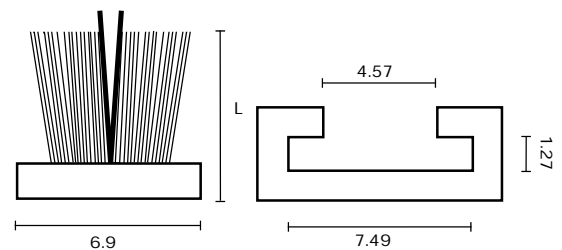

SC-PBF69

Color Code	Description
G	Grey

Color Code	Description
B	Black



* Timber Seal Available

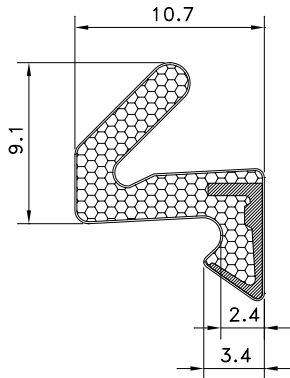

Aquamac 21

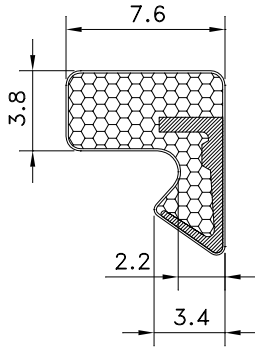

Aquamac 48

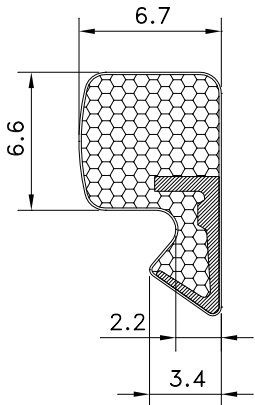

Aquamac 63

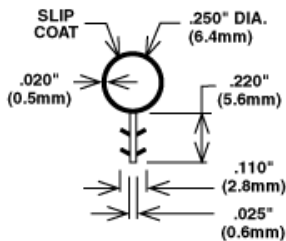

Kerf Seals AP 425

Schlegel Aquamac

AQUAMAC is the only non-rot weatherseal specifically for timber windows and doors.

Schlegel's AQUAMAC Weatherseal stays looking good for years, its water repellent foam is unaffected by rot, mould or mildew and will not freeze to mating surfaces

It's unique design makes Aquamac impervious to paint and stain, which can be a big time saver when it comes to maintenance.

AQUAMAC maintains consistently high standards of energy efficiency, often exceeding any long-term window performance guarantees.

Lifetime guarantee.

Doesn't shrink or stretch, even in extreme climatic conditions

Excellent memory - retains its original shape for a consistently high standard of weatherseal

Exceptional performance maintained over a wide temperature range.

High wear resistance reduces wear and tear Immune to the effects of UV light and ozone

Impervious to paint or stain - reducing decoration maintenance costs

Lower insertion forces speed up fitting by 15%

CFC free - more environmentally friendly

Outstanding energy efficiency

Conforms to BS644/BBA approval

Compensates for window movement

Available in 2 standard colours - White and Brown. Others available

All Stock available by the metre.

Part No.	Description	Length
SC-AQ21 ••	Aquamac 21	250 m

Part No.	Description	Length
SC-AQ48 ••	Aquamac 48	350 m

Part No.	Description	Length
SC-AQ63 ••	Aquamac 63	300 m

Part No.	Description	Length
SC-AP425 ••	Kerf Seals AP 425	382 m
SC-A415 ••	Kerf Seals AP 415 (Off Set)	305 m

Color Code	Description
B	Bronze
W	White

Color Code	Description
BLK	Black
BE	Beige



Timber



Raven RP8SI

• A concealed, automatic door bottom seal that is spring loaded to lift clear of the floor when the door is opened. It is acoustically designed, featuring silicon gaskets for medium temperature smoke and fire door applications. Operated automatically by pressure against the door jamb on its adjustable strike. RP8Si can also be fitted into the bottom rail of a metal door by the fabricator. Has a level adjustment to achieve an optimum seal.

Part No.	Available Lengths
RP-8SI	1220mm, 1070mm, 920mm, 820mm, 600mm, 380mm to 295mm(min). Seals cut back to exact size.

Color Code	Description	Color Code	Description
A	Anodised	B	Bronze
C	Clear		

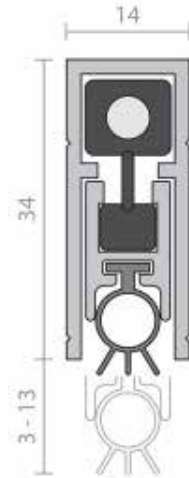

Raven RP38SI

• A heavy duty, automatic door bottom seal that is spring loaded to lift clear of the floor when the door is opened. It is self levelling and reversible for left and right handed operation. Acoustically designed, it features a silicon gasket for medium temperature smoke and fire door applications. Doubles as a kick plate when semi-morticed. Operated automatically by pressure against the door jamb or stop on its adjustable brass strike

Part No.	Available Lengths
RP-38SI	1500mm, 1220mm, 1070mm, 920mm, 610mm, 450mm to 300mm(min). Seals cut back to exact size.

Color Code	Description	Color Code	Description
B	Bronze	S	Silver

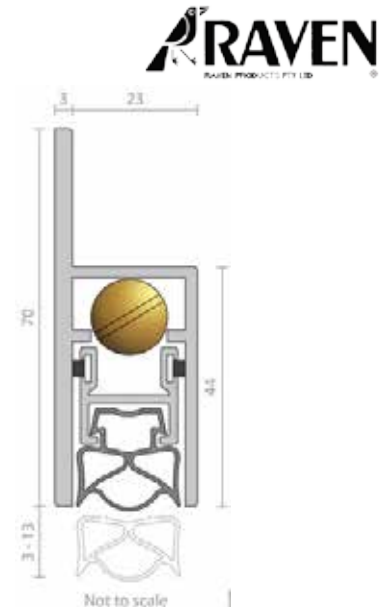

Raven RP99SI

A heavy duty, adjustable, automatic door bottom seal that is spring loaded to lift clear of the floor when the door is opened. Acoustically designed, with a silicon gasket for medium temperature smoke applications. Operated automatically by pressure on the door jamb or stop by its adjustable strike. Includes aluminium cover for concealed fixing for face mounted installation.

Part No.	Available Lengths
RP-99	1220mm, 1070mm, 920mm, 820mm, 720mm, 600mm, 380mm to

Color Code	Description	Color Code	Description
A	Anodised	S	Satin
C	Clear	B	Bronze

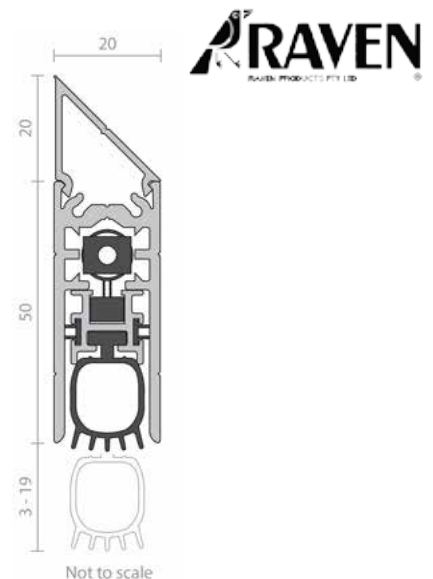



Raven RP4

A storm proof door bottom seal and threshold plate that is ideal where maximum weather protection is required. The RP4 multi-blade seal defies rain infiltration.

Can be fitted to the square cut bottom of a door without removing the door, provided there is an existing gap of 25mm. It is quick and easy to fit to both door and sill.

The sealing section is slotted for adjustment.

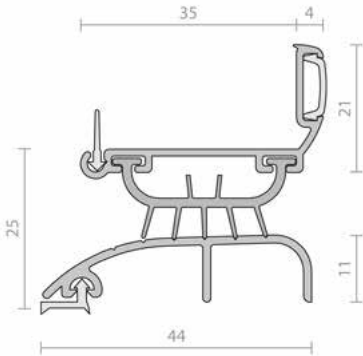

Part No.	Available Lengths
RP-4	Available in stock lengths.

Color Code	Description	Color Code	Description
A	Anodised	G	Gold
C	Clear	B	Bronze



Raven RP89

- A rigid and flexible co-polymer weather and energy seal. RP89 suits leading proprietary brand, hollow channel aluminium door suites. Concealed in the bottom of aluminium butt hinged doors or the bottom and head of pivot doors, RP89's unique design accommodates OEM and retrofit applications.

When used in conjunction with a Raven threshold plate an excellent weather and energy seal is achieved.



Part No.	Available Lengths
RP-89	1000mm



Raven RP10

- An effective acoustic door stop frame seal which is quick and easy to install on plain or rebated door frames. Multi-fin design for improved noise and energy sealing. The minimum deflection design creates maximum sealing efficiency.

RP10 can be mitred or butt jointed for a neat finish. Adjustable by large concealed fixing slots for a precision fit. RP10 has a tamper resistant, rigid PVC cover strip (SE). Can be used on all four sides of the door to form a bulk head seal.

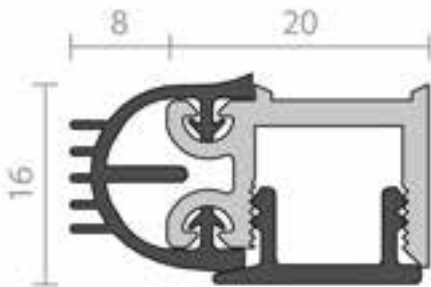

Part No.	Available Lengths
RP-10	Available in door set sizes or stock lengths.

Color Code	Description	Color Code	Description
C	Clear	B	Bronze

Raven RP85



• A refrigeration type vinyl magnetic strip in an anodised aluminium housing with concealed fixings. RP85 provides a tight seal for steel clad doors and jambs and may be used as a stop. For timber doors, a thin steel strip can be attached to the door face. The magnetic strip has sufficient closing strength that latches may not be required.

Part No.	Available Lengths
RP-85	Available in stock lengths.

Color Code	Description	Color Code	Description
A	Anodised	C	Clear

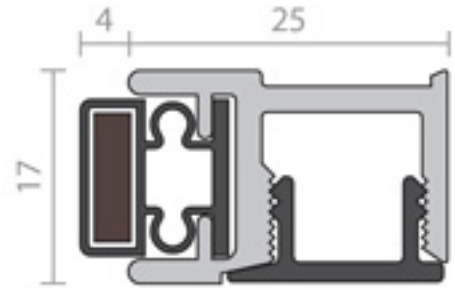

Raven RP129



• A heavy duty medium temperature smoke and weather door bottom seal. The RP129Si can be checked out or drilled to accommodate pivot hardware whilst still providing a continuous seal.

Use in conjunction with RP130Si and a Raven threshold plate (essential).

Part No.	Available Lengths
RP-129	Available in stock lengths.

Color Code	Description	Color Code	Description
A	Anodised	C	Clear

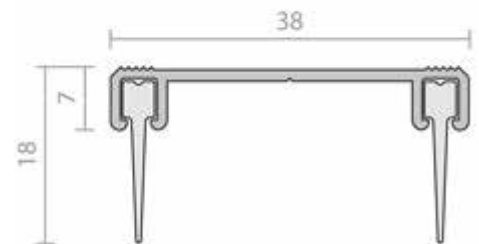

Raven RP130



• A heavy duty medium temperature smoke seal designed to be fitted to the door head & jamb reveal of pivot door frames. May also be installed to the door stile edges and to one leaf of plain meeting stiles of timber double pivot doors. The aluminium body of the seal can be checked out or drilled to accommodate pivot hardware and latch ware at the meeting stile.

Part No.	Available Lengths
RP-130	Available in door set sizes or stock lengths.

Color Code	Description	Color Code	Description
A	Anodised	C	Clear

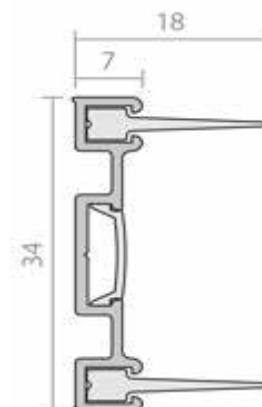

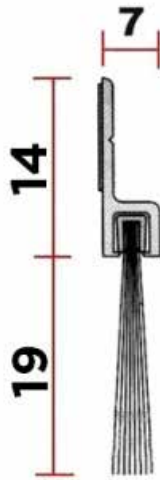

Raven RP2A

• A nylon brush strip seal, with an aluminium carrier, that mounts to the inside or outside of a door. It is ideal for sliding or double acting doors. When fitted by the fabricator, the seal can be concealed inside of an aluminium door suite bottom rail.

Part No.	Available Lengths
RP-2A	915mm



Raven RP2B

• A nylon brush strip seal with an anodised aluminium carrier that mounts to the inside or outside of a door.

Used in conjunction with Raven threshold plates.

Part No.	Available Lengths
RP-2B	Available in stock lengths.

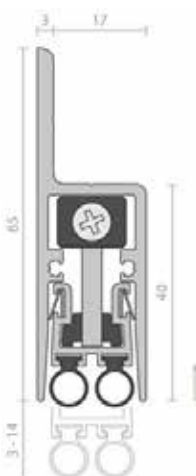

Raven RP126Si

• An adjustable, automatic door bottom seal that is spring loaded to lift clear of the floor when the door is opened. Acoustically designed, featuring extruded silicon gaskets for medium temperature smoke applications. RP126Si is operated automatically by pressure on the door jamb or stop by its adjustable strike.

Part No.	Available Lengths
RP-126Si	1500mm, 1220mm, 1070mm, 920mm, 820mm, 600mm to 305mm(min). Seals cut back to exact size.

Color Code	Description	Color Code	Description
C	Clear	s	Silver

Raven RP127Si



- An adjustable, automatic door bottom seal that is spring loaded to lift clear of the floor when the door is opened. Acoustically designed, featuring extruded silicon gaskets for medium temperature smoke applications. It is operated automatically by pressure on the door jamb by its adjustable strike.

Part No.	Available Lengths
RP-127Si	1500mm, 1220mm, 1070mm, 920mm, 820mm, 600mm to 305mm(min). Seals cut back to exact size.

Color Code	Description	Color Code	Description
C	Clear	S	Silver

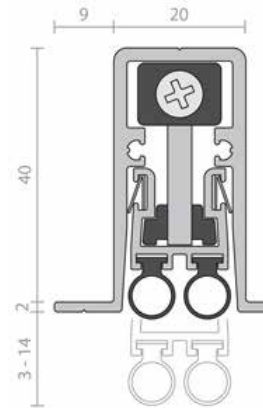

Raven RP128Si



- An adjustable, automatic door bottom seal that is spring loaded to lift clear of the floor when the door is opened. Acoustically designed, featuring extruded silicon gaskets for medium temperature smoke applications, the RP128Si is operated automatically by pressure on the door stop by its adjustable strike. Utilising an aesthetic extruded aluminium cover for concealed fixing.

Part No.	Available Lengths
RP-128Si	1500mm, 1220mm, 1070mm, 920mm, 820mm, 600mm to 305mm (min). Seals cut back to exact size.

Color Code	Description	Color Code	Description
B	Black Anodised	S	Silver

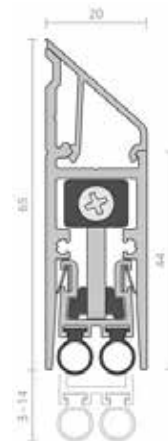

Raven RP74F



- A nylon brush strip seal that is ideal for sliding or double acting doors. Can also be used for the stiles of tilt-up doors. The brush houses a unique medium temperature fin, which is effective in the sealing of medium temperature smoke, noise and weather.

Used in conjunction with Raven threshold plates

Part No.	Available Lengths
RP-74F	Available in stock lengths.

Color Code	Description	Color Code	Description
B	Bronze	S	Sliver

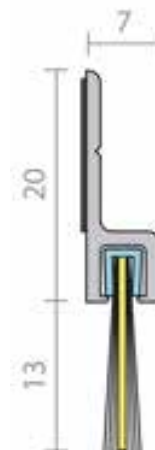



SEALS